

SECTION A-A

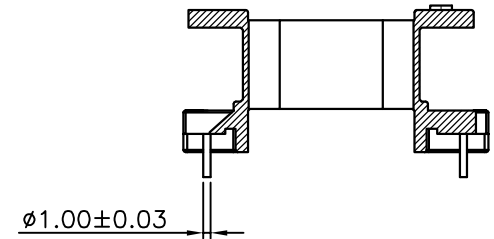

SECTION B-B

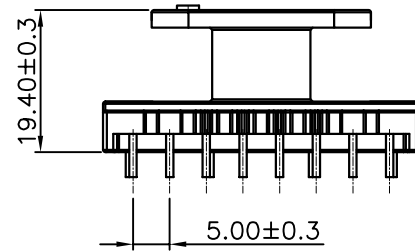
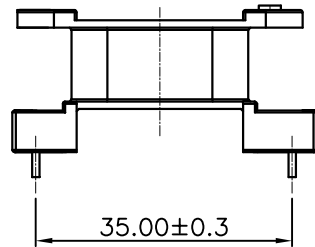
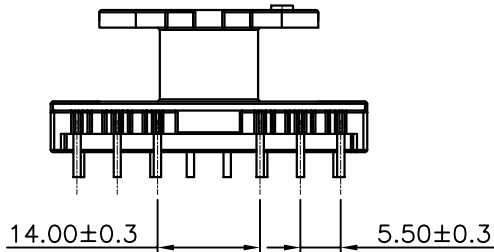
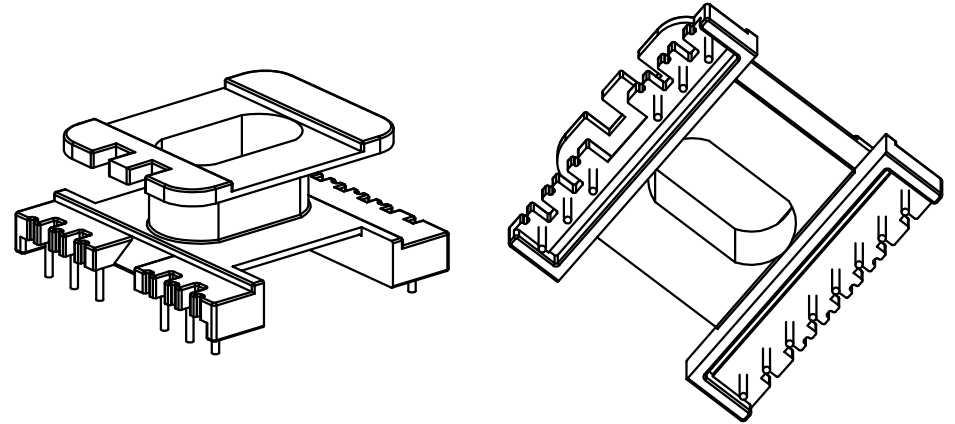
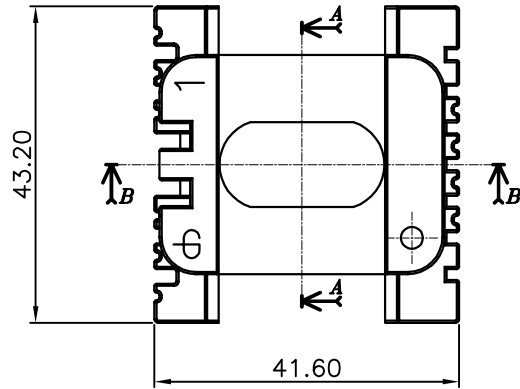
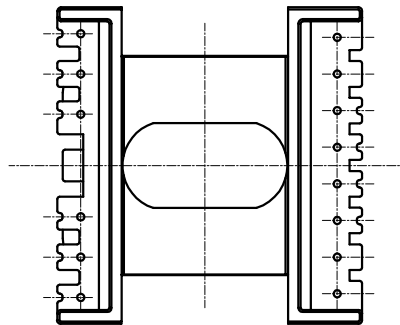

▲							
▲							
▲							
▲							
MARK	REVISION NOTE			DATE	DRAWN	CHECKED	APPROVED
	DRAWN	CHECKED	APPROVED	MATERIAL : PHENOL	UL REC. : UL94V-0	THIRD ANGLE PROJ.	SCALE : 1/1
	HK, Yang	SH, Kim	C, Park	Z : PIN LENGTH (According to customer's request)	DATE : 12.10.12	TOLERANCE : ±0.2 (Unless otherwise specified)	UNIT : m/m
	주희회사 대흥보빈 DAE HEUNG BOBBIN CO., LTD			TITLE EED 40*20 "V" (14P)		DWG NO DH-121031-6039-07	